

SLOPE TOP CORNER

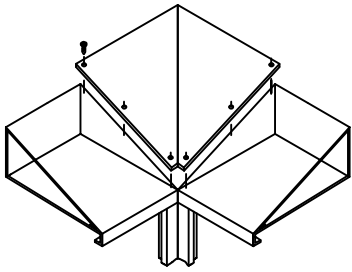

USE FILLER PLATE AS TEMPLATE, DRILL 1/8" DIAMETER HOLES INTO LOCKER UNIT AS SHOWN.
HARDWARE: (6) SHEET METAL SCREWS

SLOPED TOPS

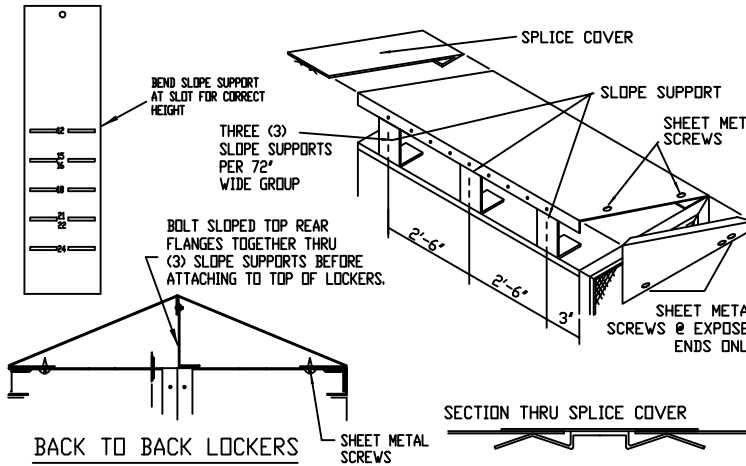

1. LEVEL AND BOLT LOCKERS TOGETHER BEFORE ATTEMPTING TO INSTALL SLOPED TOPS.
2. BOLT REAR FLANGE OF TOP TO (3) SLOPE SUPPORTS AS SHOWN (FOR BACK-TO-BACK LOCKERS BOLT THE REAR FLANGE OF BOTH TOPS TO SLOPE SUPPORTS).
3. ATTACH END CLOSURE FOR CONCEALED CONDITION ONLY USING (2) TEK SCREWS THRU SLOPE TOP.
4. SLIP SPLICE COVER ONTO THE ENDS TO BE JOINED, THEN PUT WHOLE ASSEMBLY ONTO THE TOP OF THE LOCKERS & ALIGN.
5. DO THE SAME WITH THE NEXT SECTION OF SLOPE TOP AND SLIP INTO THE SPLICE COVER OF THE SECTION ALREADY FASTENED.
6. CUT LAST SECTION TO REQUIRED LENGTH AND SLIP CUT EDGE INTO THE LAST ATTACHED SPLICE COVER, THEN ATTACH SLOPE TOP TO END CLOSURE USING TEK SCREWS.
7. FASTEN THE FRONT FLANGE THROUGH THE HOLE IN THE FLAT TOP. (3) TEK SCREWS PER SLOPE TOP.
8. WHEN ALL FRONT FLANGES ARE FASTENED, ALIGN EXPOSED SLOPE END CLOSURES. FIRST FASTEN TO THE LOCKER.

NOTE: DO NOT ATTACH FRONT FLANGES OF SLOPE TOPS TO LOCKER UNTIL ALL SLOPE TOPS ARE ALIGNED FOR AN ENTIRE RUN. ALL BOXED ENDS MUST BE ATTACHED PRIOR TO CONTINUOUS SLOPE TOPS.

FLAT TOP CORNER

USE FILLER PLATE AS TEMPLATE AND DRILL 1/8" DIAMETER HOLES INTO LOCKER UNIT AS SHOWN.

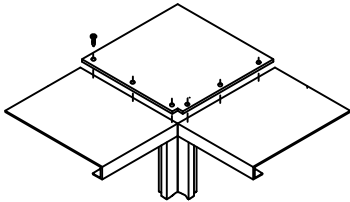

HARDWARE:
PAN HEAD SHEET METAL SCREWS.

TOP FILLER

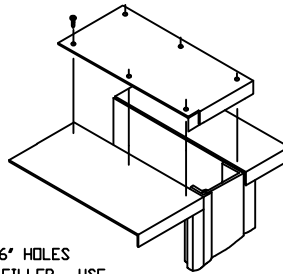

DRILL (6) 3/16" HOLES AS SHOWN IN FILLER, USE FILLER AS TEMPLATE AND DRILL (6) 1/8" HOLES IN LOCKER TOPS. ATTACH WITH SHEET METAL SCREWS.

NOTCH FRONT BEND OF FILLER AS REQUIRED TO PROVIDE CLEARANCE OF SLIP FILLER.

HARDWARE:
PAN HEAD SHEET METAL SCREWS

UNIT TO BASE

INSTALL ONE SCREW AT EACH END OF UNIT

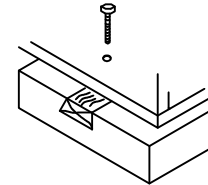

CONCRETE BASE AND WOOD SLEEPER BY OTHERS

IMPORTANT: LOCKERS MUST BE LEVEL. USE CEDAR SHIMS IF NECESSARY TO PROVIDE FOR IRREGULARITIES IN BASE.

HARDWARE:
(2) 1/4" X 4" HEX HEAD LAG SCREWS (SUPPLIED BY INSTALLER)

SOLID END PANEL

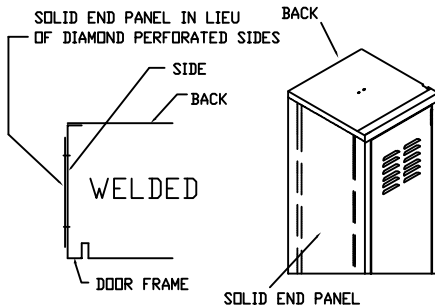

SOLID END PANEL FOR DEAD CORNERS & FILLER CONDITIONS SECURED TO LOCKER WITH SHEET METAL SCREWS

BOXED END PANEL

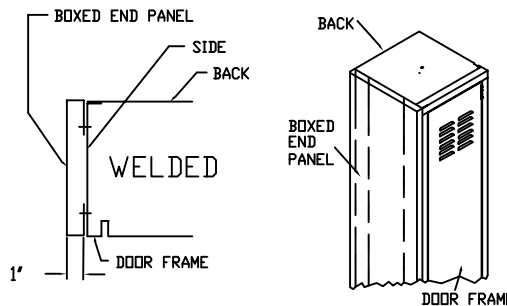

BOXED END PANEL TO BE SECURED TO LOCKER WITH SHEET METAL SCREWS

NUMBER AND STRIKE PLATES

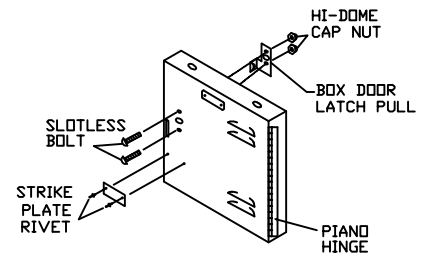

ASSEMBLY OF STRIKE PLATE & LATCH PULL

RECOMMENDED TOOLS

'C' CLAMPS, HAMMER DRILL, VICE GRIPS
SABER SAW, 3/8" ELECTRIC DRILL
3/8" NUT DRIVER, ASSORTED CEDAR SHIMS,
ELECTRIC SCREW GUN W/ADJUSTABLE TORQUE
WONDER BAR, #2 & #3 PHILLIPS BITS
RIVET GUN & 5/16, 3/8 AND 7/16" HEX DRIVES



2823 W Orange Ave., Apopka, FL 32703
Phone: 866-566-0500 Fax: 407-464-3610

REVISIONS

NO.	DATE	BY
1.	02-10-04	JMH
2.	08-20-04	JMH
3.	-	-
4.	-	-

INSTALLATION DETAILS FOR WELDED LOCKERS

DRWN BY	TEB	DATE	03/29/01	SCALE	NONE
CHK'D	MDS <td>DATE <td>03/29/01 <td>DRWG NO.</td> <td>SB-2270-1</td> </td></td>	DATE <td>03/29/01 <td>DRWG NO.</td> <td>SB-2270-1</td> </td>	03/29/01 <td>DRWG NO.</td> <td>SB-2270-1</td>	DRWG NO.	SB-2270-1
APP'D		DATE			

PEDESTAL TO BENCH

UNIT END FILLER

USING PEDESTAL AS A TEMPLATE LOCATE CENTERS, DRILL 7/32" HOLES, AND ATTACH WITH SCREWS PROVIDED. FLOOR ANCHORS PROVIDED BY INSTALLER, RECOMMENDED HILTI ALUMINUM HIT ANCHORS CAT. NO. 5400192 OR 1/4" X 2" TAP-CON.

HARDWARE-(PER PEDESTAL)

#4805 STD. STEEL TUBING (NOT SHOWN)
(3) #14 x 1" HEX WASHER HEAD SHEET METAL SCREWS

#4810 HEAVY DUTY CAST IRON
(3) #14 x 1" HEX WASHER HEAD SHEET METAL SCREWS

#4820 FORMED ALUMINUM
(4) #14 x 1" HEX WASHER HEAD SHEET METAL SCREWS

#4825 STAINLESS STEEL (NOT SHOWN)
(4) #14 x 1" HEX WASHER HEAD SHEET METAL SCREWS

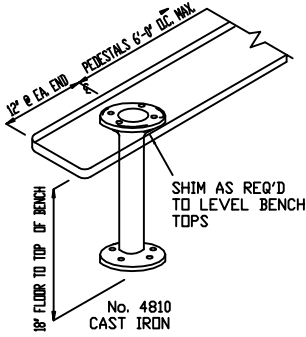

HARDWARE FOR 8032 PEDESTAL		
QTY.	PART#	DESCRIPTION
4	SMS-105	#14 x 1" SHEET METAL SCREW HEX WASHER HEAD
1	8037	1/2-6 x 5" LG. STEEL HEX LAG BOLT ZINC PLATED
1	8038	1/2" x 7/8" x 1/8" STEEL LOCK WASHER-ZINC PLATED
1	8039	1/2" ID x 3/4" OD x 2" LG. LAG SHIELD
1	TV2	17/32" x 1-1/4" x 3/32" STEEL FLAT WASHER-ZINC PLATED

DETERMINE SIZE OF OPENING AND CUT FILLER TO SIZE. ATTACH FILLER TO FRAME WITH SMS102B. PLACE LOCKER UNIT ON BASE AND BUTT END OF FILLER TO WALL.

PEDESTAL ARRANGEMENT

ALL PEDESTALS TO BE LOCATED 12" FROM EACH END WITH A MAXIMUM OF 6'-0" SPACING. ON BENCH LENGTHS GREATER THAN 8'-0", (3) PEDESTALS ARE REQUIRED.

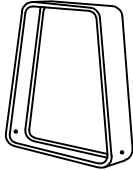

No. 4820 MOVEABLE ALUMINUM

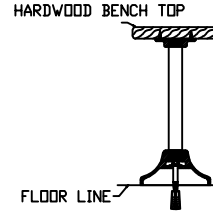

No. 8032 CAST ALUMINUM

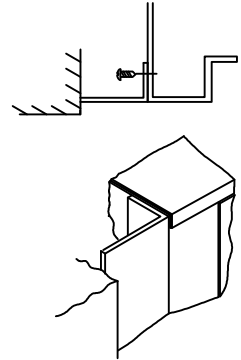

END FILLER

SLIP FILLER

ATTACH FILLER TO FRAME WITH TEK SCREWS ON ONE FOOT CENTERS. SET UNIT IN PLACE AND SLIDE TOWARD LOCKER AS SHOWN. ATTACH FILLER TO LOCKER THROUGH THE FRAME ON ONE FOOT CENTERS USING #10 x 1 1/2" FLAT HEAD SELF TAPING SCREWS.

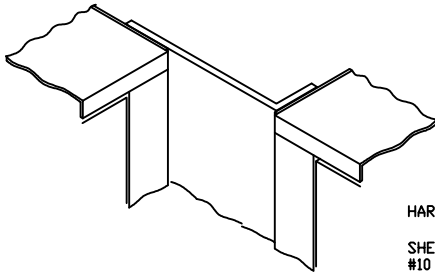

HARDWARE:
SHEET METAL SCREWS
#10 FLAT HEAD SCREWS

CUT FRONT FILLER TO PROPER WIDTH AS SHOWN. ATTACH TO WALL SO THAT THE FACE IS FLUSH. ATTACH SLIP JOINT TO UNIT WITH TEK SCREWS ON ONE END. SET UNIT IN PLACE AND SLIDE TOWARD FRONT FILLER UNTIL INSERTED IN SLIP JOINT AS SHOWN.

IF FILLER IS BETWEEN UNITS, ATTACH FRONT FILLER TO SIDE OF LOCKER FRAME ON ONE FOOT CENTERS.

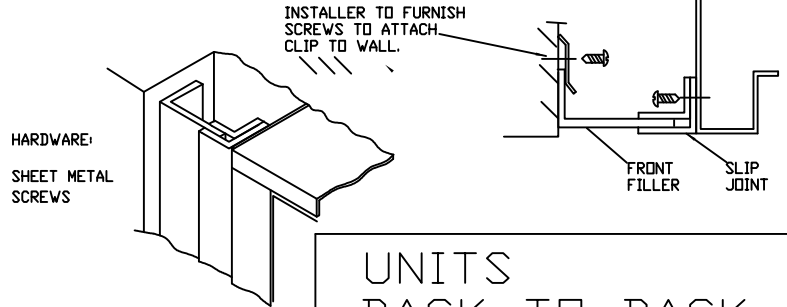

HARDWARE:
SHEET METAL SCREWS

INSTALLER TO FURNISH SCREWS TO ATTACH CLIP TO WALL.

FRONT FILLER
SLIP JOINT

UNITS BACK TO BACK

UNITS END TO END

UNITS TO WALL

DRILL 9/32" HOLE THRU BACKS OF LOCKERS APPROX. 2" FROM UPPER CORNER ON EACH SIDE OF UNIT.

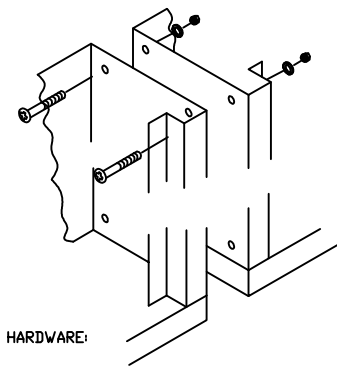

HARDWARE:
(4) 1/4"-20 X 3/4" PHILLIPS PAN HEAD SCREWS
(4) 1/4"-20 HEX NUT
(4) 1/4" EXTERNAL TOOTH LOCK WASHER

DRILL 9/32" DIA. HOLE THRU BACK SHEET OF LOCKER AND INTO WALL APPROX. 2" FROM UPPER CORNER ON EACH SIDE OF UNIT.

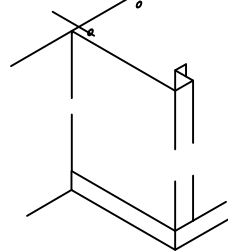

HARDWARE:
(2) ANCHORS BY INSTALLER-RECOMMENDED HILTI ALUMINUM HIT ANCHORS CAT. LND. 5400192
1/4" X 2" TAP-CON OR QUICK.

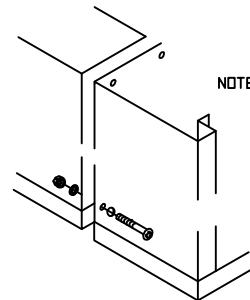

NOTE: BOLT BACK TO BACK LOCKERS AT (4) FOUR CORNERS.

HARDWARE-SOLID BACK:

(4) 1/4"-20 X 3/4" PHILLIPS PAN HEAD SCREWS
(4) 1/4"-20 HEX NUT
(4) 1/4" EXTERNAL TOOTH LOCK WASHER

IN THE INTEREST OF SAFETY, ALL WELDED LOCKERS MUST BE SECURELY ANCHORED TO THE FLOOR AND/OR WALL.



2823 W Orange Ave., Apopka, FL 32703
Phone: 866-566-0500 Fax: 407-464-3610

REVISIONS

NO.	DATE	BY
1.	02-10-04	JMH
2.	08-20-04	JMH
3.		
4.		

INSTALLATION DETAILS FOR WELDED LOCKERS

DRWN BY	DATE	SCALE
JMH	02/29/01	NONE
CHK'D	DATE	DRWG NO.
MDS	02/29/01	SB-2270-2
APP'D	DATE	